

XT-1 / XT Mini Manual

English



TagMaster

Note: This equipment has FCCID M39XTXX (XT-1) or M39XTMX (XT Mini). It complies with the limits for a Class A digital device, pursuant to part 15 of the FCC Rules. These limits are designed to provide reasonable protection against harmful interference when the equipment is operated in a commercial environment. This equipment generates, uses, and can radiate radio frequency energy and, if not installed and used in accordance with the instruction manual, may cause harmful interference to radio communications. Operation of this equipment in a residential area is likely to cause harmful interference in which case the user will be required to correct the interference at his own expense.

Caution: Changes or modifications not expressly approved by the party responsible for compliance could void the user's authority to operate the equipment.

Caution: To comply with Council Recommendation 1999/519/EC and FCC regulations, this reader must be installed to provide a separation distance of at least 25 cm (XT-1) or 20 cm (XT Mini) from all persons and must not be co-located or operating in conjunction with any other antenna or transmitter.

Copyright

The copyright and ownership of this document belongs to TagMaster AB. The document may be downloaded or copied provided that all copies contain the full information from the complete document. All other copying requires a written approval from TagMaster AB.

Disclaimer

While effort has been taken to ensure the accuracy of the information in this document TagMaster AB assumes no responsibility for any errors or omissions, or for damages resulting from the use of the information contained herein. The information in this document is subject to change without notice.

Table of Contents

1	Introduction	5
1.1	Readers.....	5
1.2	Tags.....	5
1.3	SecureMarkID®.....	5
2	Installation	5
2.1	Safety Instructions.....	5
2.2	Reader and Tag Placement.....	6
2.3	Mounting Instructions.....	8
2.3.1	Universal Mounting Kit (UMK).....	8
2.3.2	Dimensions.....	8
2.4	Cable Connections.....	9
2.4.1	XT-1.....	9
2.4.2	XT Mini.....	9
2.5	Wire Connections.....	10
2.5.1	Spring Cage Terminals.....	10
2.5.2	Ethernet and USB.....	10
3	Interfaces	11
3.1	Overview.....	11
3.2	Power Supply.....	11
3.3	Wiegand/Magstripe.....	12
3.3.1	Wiegand Timing.....	13
3.3.2	Magstripe Timing.....	14
3.4	Ethernet.....	14
3.5	RS232.....	15
3.6	RS485.....	16
3.7	Inputs.....	16
3.8	Light and Sound.....	17
3.9	Relay.....	18
3.10	USB.....	18
3.11	MicroSD Memory Card Slot.....	18
3.12	Tamper Switch (XT Mini only).....	18
3.13	DIP Switches.....	19
3.13.1	Interface Configuration DIP Switch (S301).....	19
3.13.2	Software Configuration DIP Switch (S101).....	19
4	Configuration	20
4.1	Web Interface.....	20
4.1.1	Start.....	20
4.1.2	Information.....	20
4.1.3	Settings.....	21
4.1.4	Access Controller.....	21
4.1.5	Web Tools.....	21
4.1.6	Documentation.....	21
4.1.7	Reboot.....	21
4.2	Region.....	22
4.3	Tag Reading.....	22
4.3.1	Carrier and Read Level.....	22
4.3.2	EPC Select.....	22
4.3.3	EPC Memory Bank/Custom Format.....	22
4.3.4	Tag Filter.....	22
4.3.5	Data Selection.....	23
4.3.6	Data Format.....	23
4.4	Firmware Upgrade.....	23
4.5	Factory Defaults.....	23

5	Connecting to an External System	24
5.1	Wiegand/Magstripe	24
5.1.1	Easy Configuration.....	24
5.2	OSDP (RS485)	27
5.2.1	Easy Configuration.....	27
5.3	Push (RS232, RS485, TCP/IP)	28
5.4	TAGP (TCP/IP).....	28
5.5	Other Protocols.....	28
6	Built-in Access Controller	29
7	Troubleshooting	30
8	Definitions and Abbreviations	30
9	References	30
10	Technical Specification	31

1 Introduction

1.1 Readers

XT-1 and XT Mini are EPC Gen 2 (ISO 18000-63) compliant RFID readers with integrated antennas. Both readers are tailored for Automatic Vehicle Identification applications such as Parking, Gated Communities and Condominiums. As such, the readers are designed for outdoor use and support a large number of interfaces and protocols. While XT-1 is a generic reader with maximum possible read range, XT Mini is optimized for pole mounting close to the vehicle lane.

EPC Gen 2 readers operate in the 860-960 MHz UHF range. To support varying global regulations, the readers come in two versions: EU that operates in the 865-868 MHz range and US that operates in the 902-928 MHz range. Both versions can be configured to work in additional regions.



Figure 1 XT-1 and XT Mini

1.2 Tags

EPC Gen 2 tags are typically passive, which means that they draw power from the reader's electromagnetic field instead of having a battery. XT-1 and XT Mini support all UHF tags that comply with the EPC Gen 2 standard. Specifically, they support the SecureMarkID[®] format developed by TagMaster to ensure that each tag has a truly unique identity that is difficult to clone.

1.3 SecureMarkID[®]

The EPC Gen 2 standard was not originally developed for access control and therefore has a few weaknesses in these applications. Even if all modern tags have a unique ID, this is often too long for existing access control systems and tags cannot be bought with the IDs in sequence. User-programmed tags can often be cloned by anybody with access to an EPC Gen 2 reader.

To address this issue, TagMaster has developed the SecureMarkID[®] format that uses an encryption algorithm and non-writable parts of the tags to create a unique 9-digit ID that works well with access control systems, can be bought in sequence, and is difficult to clone. It is recommended to only use SecureMarkID[®] tags with the reader.

2 Installation

2.1 Safety Instructions

The following safety instruction should be observed during installation, normal use, and service.

- Installation and service should only be done by qualified personnel.
- Shields of cables should be connected to safety ground.
- The reader must be disconnected from all voltage sources before any installation or service work. Capacitors inside the reader can hold their charge even if the equipment has been disconnected from all voltage sources.
- Do not modify any part of the product. Repair is to be performed by TagMaster only.
- Where local regulations exist, these are to be followed. The safety information in this manual is a supplement to local regulations. It is the responsibility of the local project manager to make certain that local regulations are known and followed.

2.2 Reader and Tag Placement

Figure 2 shows some typical installations for the XT-1 reader:

- A. Single lane parking entrance. The reader is directed to read windshield or headlight tags.
- B. Multilane parking entrance. To minimize the risk for cross reads, the readers are mounted above the cars and the cars are equipped with windshield or headlight tags.
- C. Access control (at the gate) and vehicle identification (at the weighbridge). The trucks are equipped with ISO card tags that are mounted in a holder on the windshield and read from the side.
- D. Traffic control. Readers are used to enable a green wave for buses.

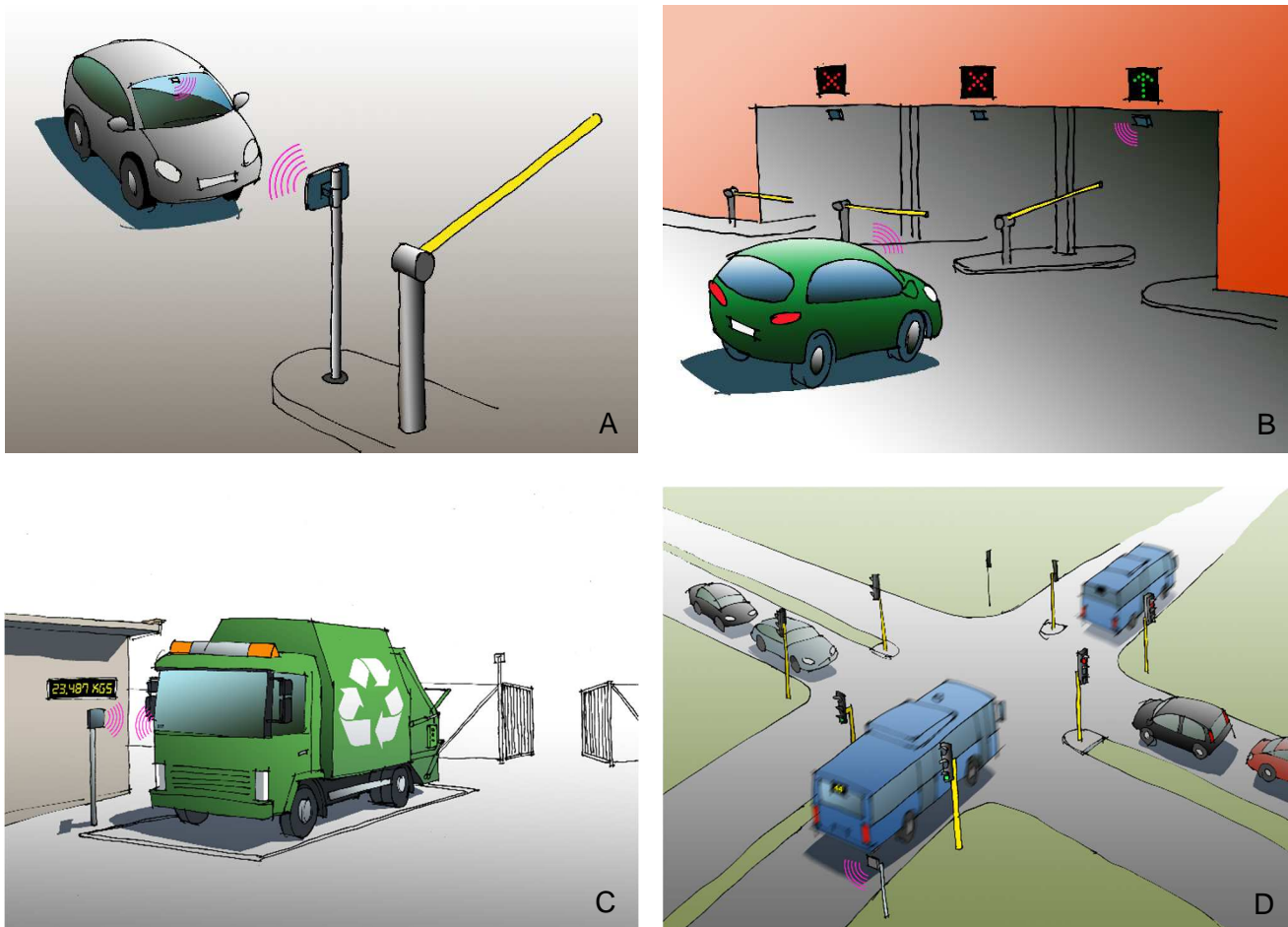

Figure 2 XT-1 installations

Figure 3 shows two installations with side-mounted readers.

- A. XT Mini is optimal for parking access with moderate read range requirements.
- B. A side-mounted XT-1 can be used to cover a wide road.

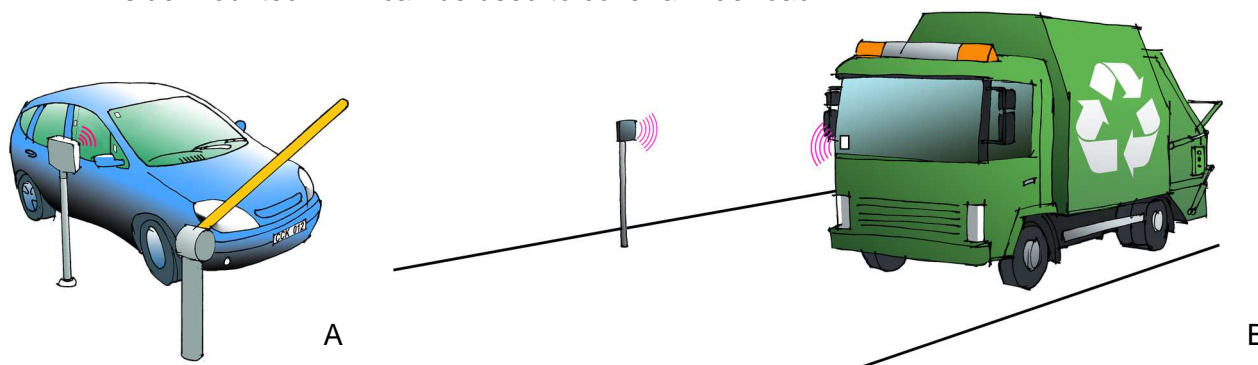

Figure 3 Side-mounted reader (A: XT Mini, B: XT-1)

The reader's radiation pattern or read lobe (the region where the reader can read tags) is shaped like a balloon in front of the reader as shown in Figure 4. The maximum read range is obtained when the tag is at the tip of the balloon. At or close to this point, the width of the balloon is very small, which means that the tag has to be accurately positioned to be read. It is recommended to mount the reader such that the tag can be read at the widest part of the balloon which is at around 60-70% of maximum read range. If required, the maximum read range can be reduced as described in section 4.3.1.

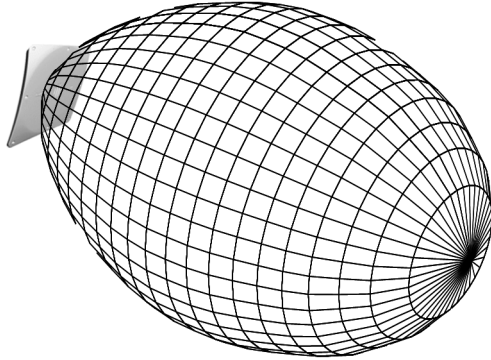

Figure 4 XT-1 radiation pattern

The reader should be mounted such that there is free sight between the reader and the tag. Radio waves from the reader cannot pass through metal or objects containing water (such as humans). Metallic objects close to the reader may cause reflections that can significantly reduce the read range.

Different tags have different mounting requirements. ISO card tags are generally optimized for free air and - if used in a car - should be mounted in a card holder that creates an air gap between the tag and the windshield. Windshield tags must be mounted on the windshield for optimal performance. Typical tags do not work if they are mounted on metal or objects containing water. Metallized windshields may prevent tag reading as they block radio waves.

Most EPC Gen 2 tags have a donut shaped radiation pattern as shown in Figure 5. This means that the tags can be read not only when the front side is facing the reader, but also when the backside or long edges are facing the reader. If the tag is turned such that one of the short edges is facing the reader, the read range drops rapidly.

If the reader is mounted beside the car, the tag should be mounted with the donut lying as shown in the left part of Figure 5. Note that the tag can be mounted in the windshield and read when the long edge of the tag is facing the reader. If the windshield is metallized, the tag can be mounted in the side window or on the front of the B-pillar (with a suitable holder creating a distance from the metal). A side-mounted reader together with a tag with a lying donut can be used to cover a wide road as shown in Figure 3 B.

If the reader is mounted above or in front of the car, the tag should be mounted with the donut standing as shown in the right part of Figure 5. In a multilane installation (Figure 2 B) it is recommended to mount the tags like this with the reader above the car to reduce the risk of cross reads. If the windshield is metallized, a transparent tag can be mounted on the headlight.

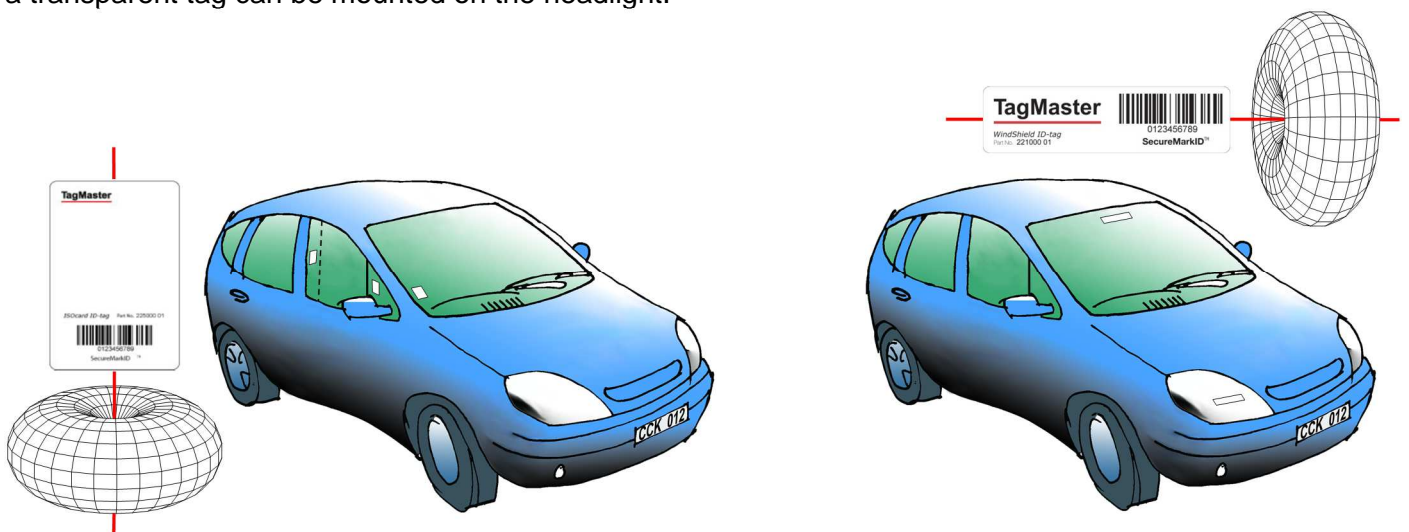

Figure 5 Tag radiation patterns and example placement

2.3 Mounting Instructions

Mount the reader in a horizontal position with the cable glands down. Study the installation examples and radiation patterns in section 2.2 to determine the optimal placement of readers and tags in your installation.

2.3.1 Universal Mounting Kit (UMK)

The UMK (TagMaster part. no. 193600) makes it easy to mount the reader in a wide variety of positions and angles. The kit contains all parts needed to mount the reader on a wall or a pole. The kit is designed and suitable for outdoor use. See separate datasheet [1] for more details in on installation.



Figure 6 Universal Mounting Kit (UMK)

2.3.2 Dimensions

Reader dimensions are shown in Figure 7 (XT-1 to the left, XT Mini to the right).

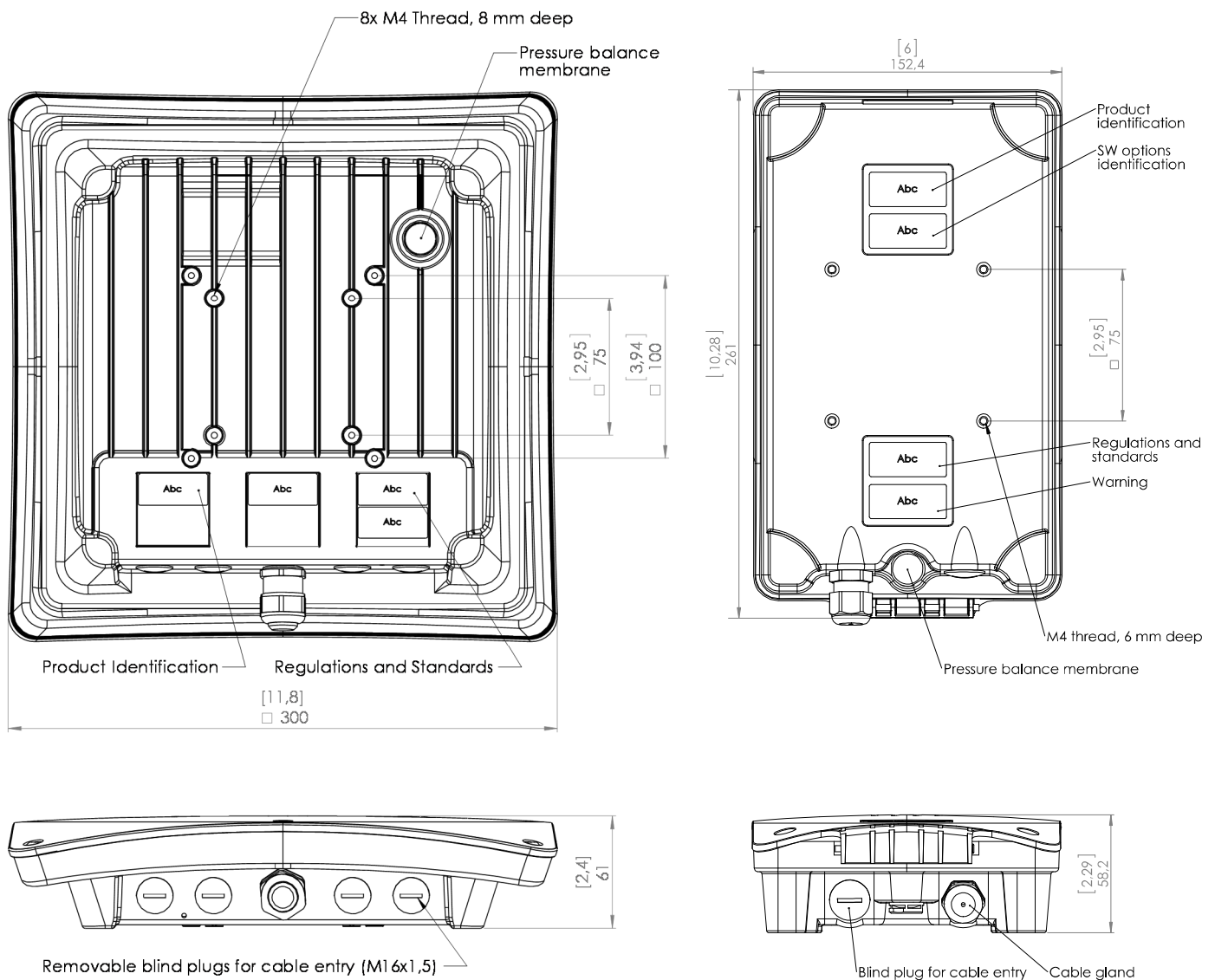

Figure 7 Reader Dimensions in [inch] and mm

2.4 Cable Connections

2.4.1 XT-1

In XT-1, cables should primarily be connected through the central M20 cable gland. This cable gland can be used with one cable (\varnothing 6-12 mm) or two cables (\varnothing 2-6 mm) using the supplied insert. As an alternative, one or more of the four M16 blind plugs can be replaced with cable glands. Use shielded flexible cables with stranded wire. Ground the reader chassis using the grounding screw.

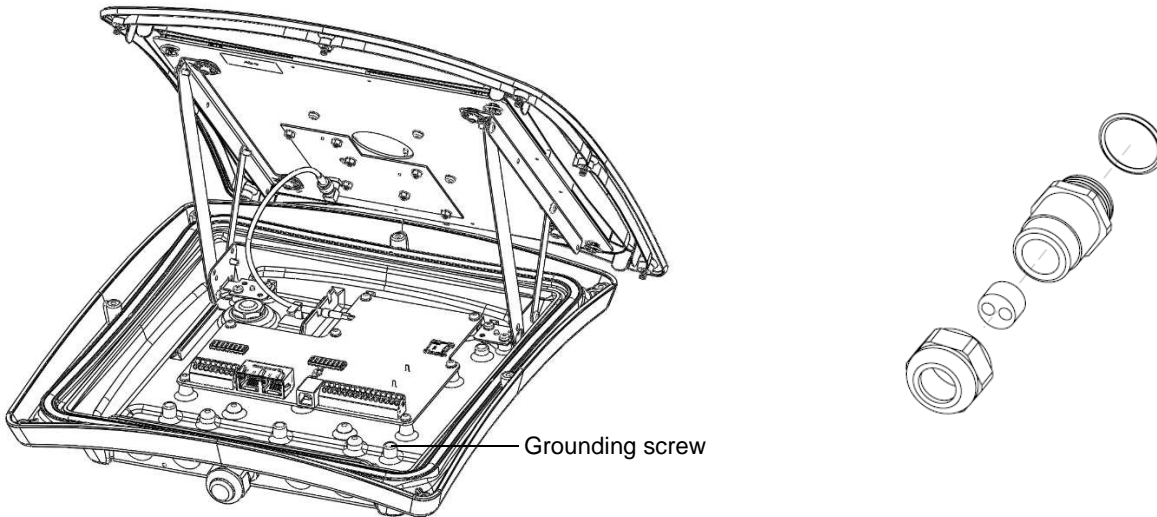

Figure 8 XT-1 with open lid (left), cable gland with insert for two cables (right)

2.4.2 XT Mini

In XT Mini, cables should be connected through the two M16 cable glands. A cable tie should be used to guide the wires when the lid is closed. Make sure to use cables with flexible wires. It is recommended to use the left cable gland for Ethernet connections and the right cable gland for other connections. An example with power, Ethernet and RS485 connections is shown in Figure 9.

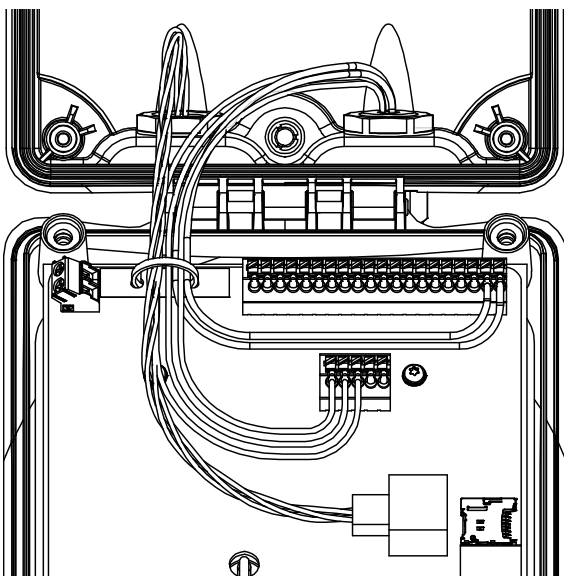
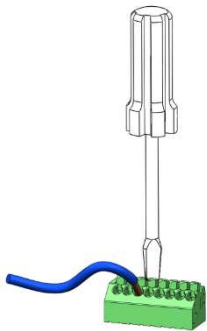

Figure 9 XT Mini with power, Ethernet and RS485 connections

2.5 Wire Connections

2.5.1 Spring Cage Terminals



With the exception of Ethernet and USB, all wires are connected to spring cage terminals. These terminals are easy to use and work with both solid and stranded wires.

Instructions

1. Strip wire lead approximately 9 mm.
2. Push screwdriver down to release spring cage.
3. Insert wire into terminal.
4. Remove screwdriver to clamp wire.
5. Gently pull installed wire to make sure connection is reliable.

Wire size	0.5 mm ² - 1.5 mm ² (AWG 20 - AWG 16)
-----------	---

Table 1 Wire connection overview

2.5.2 Ethernet and USB

Ethernet connections are made with standard RJ45 connectors. Make sure to pass the Ethernet cable through the cable gland before crimping the connector to the cable.

USB is intended for service and maintenance and is therefore connected only when the lid is open. Connection is done using a standard USB type B cable.

3.3 Wiegand/Magstripe

The reader has a software configurable Wiegand/Magstripe interface.

Connections (Wiegand)	WIEG:D0	Wiegand 0
	WIEG:D1	Wiegand 1
	WIEG:CL	Card load
	WIEG:GND	Signal ground #1
Connections (Magstripe)	MAG:CLK	Magstripe clock
	MAG:DATA	Magstripe data
	MAG:LOAD	Card load
	MAG:GND	Signal ground #1
Max cable length	100 m (depending on properties of receiving system)	
Wire size	0.5 mm ² (AWG 20), 1.5 mm ² (AWG 16) above 10 m of length.	
Voltage	Typ 5 V / Max 30 V	
Sink current	Max 500 mA	
Isolation	Min 1500 VDC	

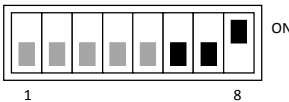
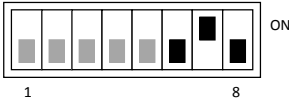

Table 4 Wiegand connection overview

All Wiegand/Magstripe settings are available under Settings.../Interfaces.../Wieg/Mag in the web interface. It is possible to select a predefined format or define a custom format.

The most common predefined formats can be selected by setting DIP switches S101:6-8 as shown in the table below. When any of these switches are in the ON position, the reader is also configured to report tags once and only accept SecureMarkID tags.

The following formats can be selected by DIP switches:

- D = Data from tag (bit for Wiegand/digit for Magstripe)
- S = Value of Site code
- E = Even parity bit, O = Odd parity bit, X = Bit included in parity calculation
- B = Magstripe start character, F = Magstripe stop character, L = Magstripe LRC

Output Format	Description
<p>W26S/H10301</p> <p>S101</p> 	<p>26-bit Wiegand (8-bit site code, 16-bit data):</p> <pre> ESSSSSSSSDDDDDDDDDDDDDDDDDDO XXXXXXXXXXXXXXXXX----- -----XXXXXXXXXXXXXXXXX </pre>
<p>W26N/H10301</p> <p>S101</p> 	<p>26-bit Wiegand (24-bit data, no site code):</p> <pre> EDDDDDDDDDDDDDDDDDDDDDDDDDO XXXXXXXXXXXXXXXXX----- -----XXXXXXXXXXXXXXXXX </pre>
<p>W34N</p> <p>S101</p> 	<p>34-bit Wiegand (32-bit data, no site code):</p> <pre> EDDDDDDDDDDDDDDDDDDDDDDDDDDDO XXXXXXXXXXXXXXXXXXXXXXXXX----- -----XXXXXXXXXXXXXXXXXXXXXXXXX </pre>

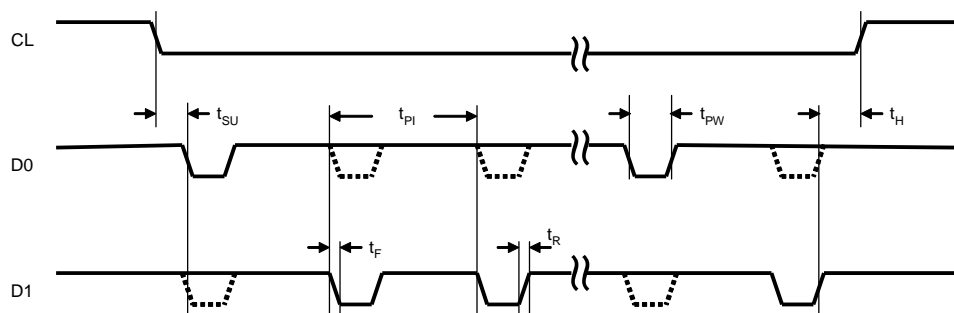

Figure 12 Wiegand timing diagram

3.3.2 Magstripe Timing

The following values apply when all outputs are pulled up to 5 V with 1 kΩ resistors.

Symbol	Parameter	Min	Typ	Max	Unit
t_{SU}	LOAD to CLK setup time		1520		μs
t_F	Fall time (all signals)		125		ns
t_R	Rise time (all signals)		5		μs
t_{CL}	Clock low		480		μs
t_{CH}	Clock high		960		μs
t_H	LOAD hold time after last CLK change		1520		μs
t_{DH}	Data hold time		880		μs

Table 7 Magstripe interface timing

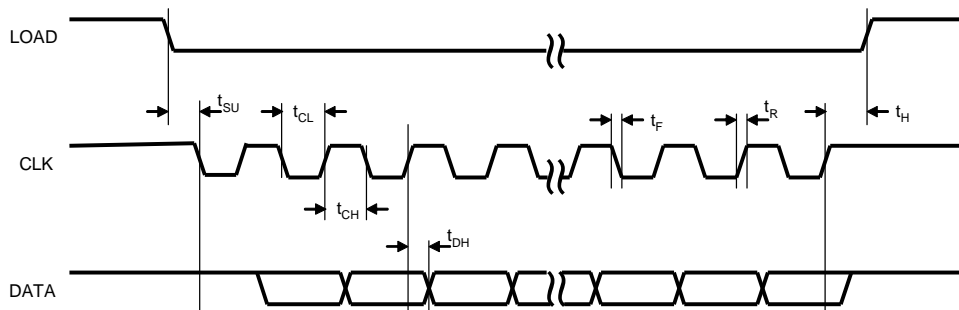

Figure 13 Magstripe timing diagram (note: data low = logic one)

3.4 Ethernet

The reader has a 10 Mbps/100 Mbps Ethernet interface with one (XT Mini) or two (XT-1) ports. The interface supports auto crossover (Auto-MDIX) so that installation can be done using either patch cables or crossover cables. Each port has two LED indicators for Link/Activity (Yellow/Flashing Yellow) and 10 Mbps/100 Mbps speed (Off/Green).

Connections	ETHERNET:A	Ethernet port
	ETHERNET:B (XT -1 only)	Ethernet port
Max cable length	100 m	
Wire size	CAT5e cable or better is required for the Ethernet connection	

Table 8 Ethernet connection overview

The reader's default IP address and subnet mask can be found on a label on the backside of the reader. The default address is on the format 10.x.x.x and the subnet mask is 255.0.0.0. All IP settings can be changed under Settings.../Interfaces.../Ethernet in the web interface. A reboot is required to activate new

settings.

For convenience, it is possible to force the reader to use a fixed IP address by setting DIP switch S101:3 to ON before starting the reader. The IP address will then be 169.254.1.1 and the subnet mask 255.255.0.0. A PC that is directly connected to a reader will usually get an IP address in this subnet automatically.

A reader discovery tool is available at <ftp://partner:245ghz@ftp.tagmaster.com/Vigilant>. This tool can find readers on a local network even if their IP settings are completely incorrect. The readers can then be restored to factory defaults and their IP settings can be configured.

The built-in Ethernet switch (XT-1 only) makes it possible to connect multiple readers in a chain.

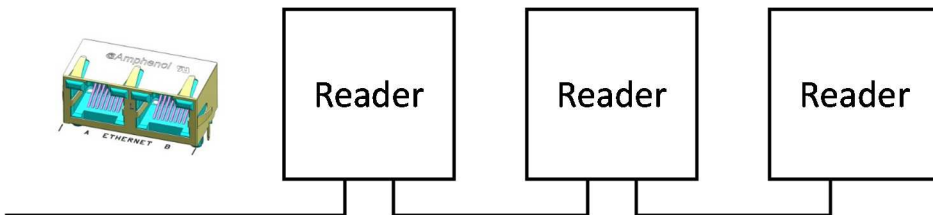

Figure 14 Readers connected in a chain using the built-in Ethernet switch

The reader supports ICMP echo request/reply (ping) to simplify network troubleshooting. By default, ping beep is enabled which means that the reader beeps when it receives a ping packet. Ping beep can be used to identify which reader that has a specific IP address or to determine if ping packets get lost on the way to the reader or from the reader. Ping beep can be disabled using the web interface.

The reader can work as a TCP server and/or TCP client. As a client, the reader automatically connects to a specified TCP server when it has data to send. The IP address and port of the server and the protocol to use can be configured under Settings.../Interfaces.../Ethernet in the web interface. Supported protocols are Push and TAGP. As a TCP server, the reader supports several protocols, including TAGP.

3.5 RS232

The RS232 interface can be used for communication with a host system.

Connections	RS232:TXD	Transmitted data to host
	RS232:RXD	Received data from host
	RX232:GND	Signal ground #2
Max cable length	10 m	
Wire size	Specification according to EIA RS232C. Belden 9184 or Belden 9502 are recommended.	
Max Baud rate	115.2 kb/s (default)	

Table 9 RS232 connection overview

The default output of the RS232 interface is tag data in ASCII format. If SecureMarkID® tags from TagMaster are being used (recommended) the numeric identity is sent out. If other EPC tags are being used the default output is the EPC data. The data is followed by CR+LF ("\r\n").

A TAGP connection can be initiated by sending the HELOTAGP message to the reader. The TAGP connection is terminated with the QUIT message. Other protocols can be enabled using the web interface. These protocols are described in separate manuals.

All RS232 settings are available under Settings.../Interfaces.../RS232 in the web interface.

3.6 RS485

The RS485 interface can be used for communication with a host system.

Connections	RS485:TX+	Transmitted data to host
	RS485:TX-	Transmitted data to host
	RS485:GND	Signal ground #3
	RS485:RX+	Received data from host
	RS485:RX-	Received data from host
Max cable length	1000 m	
Wire size	The cable for the RS485 interface must be a twisted pair cable and conform to the EIA RS485 standard.	
Max Baud Rate	115.2 kb/s (default)	

Table 10 RS485 connection overview

The hardware supports 2-wire (DIP S301:1-2 ON) and 4-wire communication, half duplex and full duplex as well as multi-drop. When using RS485 communication, correct termination of the interface should be considered in order to handle transmission-line effects. The XT-1 has a built-in option (DIP S301:3 ON) of 120 Ω termination on the receive side (to be used at each end of the RS485 chain), and an option (DIP S301:4-5 ON) of 620 Ω bias on the receive side (to be used at one node in the RS485 chain). The options using DIP switches are detailed in Figure 15 and also described in section 3.13.

With factory default settings, the reader should always be configured in 4-wire mode (DIP S301:1-2 OFF) since the TAGP protocol requires a full-duplex link. Other protocols require different settings.

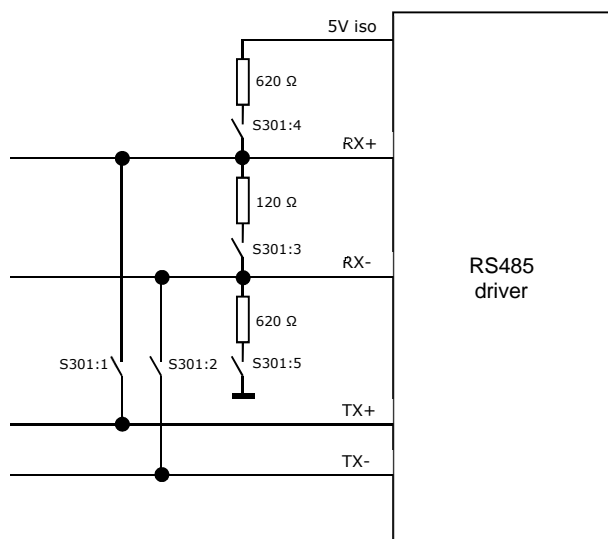

Figure 15 RS485 DIP switch configuration

The default output of the RS485 interface is tag data in ASCII format. If SecureMarkID® tags from TagMaster are being used (recommended) the numeric identity is sent out. If other EPC tags are being used the default output is the EPC data. The data is followed by CR+LF ("r\n").

A TAGP connection can be initiated by sending the HELOTAGP message to the reader. The TAGP connection is terminated with the QUIT message. Other protocols can be enabled using the web interface. These protocols are described in separate manuals.

All RS485 settings are available under Settings.../Interfaces.../RS485 in the web interface.

3.7 Inputs

The reader has 3 opto-coupled inputs.

Connections	INPUTS:IN1+	Input 1 positive terminal
	INPUTS:IN1-	Input 1 negative terminal
	INPUTS:IN2+	Input 2 positive terminal
	INPUTS:IN2-	Input 2 negative terminal
	INPUTS:IN3+	Input 3 positive terminal
	INPUTS:IN3-	Input 3 negative terminal
High Voltage (active)	Min 3.0 V / Max 30 V	
Low Voltage (inactive)	Min 0.0 V / Max 0.2 V	
Input impedance	1 kΩ	
Max cable length	100 m	
Wire size	0.5 mm ² (AWG 20)	

Table 11 Input connection overview

The inputs are activated by a current flow and the input impedance is 1 kΩ. A schematic view of an input is shown in Figure 16.

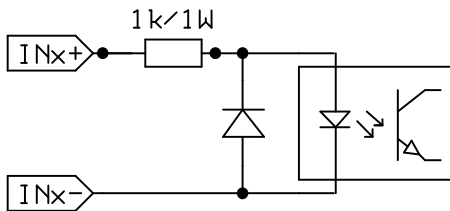

Figure 16 Input schematic

The first two inputs can be used to control the green and red LED from an external access control system to indicate if access has been granted or denied. The third input can be used as a read enable/disable input. This input can be connected to an external presence detector such as an inductive loop to make sure that the reader only reads tags when a vehicle is present.

All inputs have a debounce filter that is enabled by default. When the debounce filter is enabled, short pulses on the inputs are ignored. Pulses must be at least 20 ms to guarantee that they are detected. The polarity of the inputs can be inverted to cope with signals that are active high or active low.

The read enable/disable input can be configured to work in different modes. "Read time" is used to specify how long time reading should be enabled after it has been activated by the input. If read time is zero, reading is enabled as long as the input is active. The "Abort after read" setting can be used to abort reading after a single tag has been read (read time must be non-zero for this setting to have any effect). The "Indicator" setting is used to specify the colour of the LED when reading is enabled.

All input settings are available under Settings.../Interfaces.../Inputs in the web interface.

3.8 Light and Sound

The reader has a bright red/green/yellow LED indicator that is clearly visible on the front side of the reader. The LED indicator can show when a tag has been read and if access has been granted or denied.

A built-in buzzer can give an audible indication when a tag has been read or settings have been changed.

3.9 Relay

The relay output can be used to control a barrier, gate, or other object. The relay can either be activated when any tag has been read or when an accepted tag has been read. A tag is considered accepted when it is listed in the built-in access controller's database. The active time can be configured.

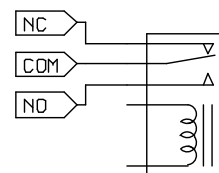

Figure 17 Inactive relay

Connections	RELAY:COM	Common
	RELAY:NO	Normally Open
	RELAY:NC	Normally Closed
Switching current	Max 2 A	
Switch voltage	Max 60 VDC / 30 VAC	
Switching capacity:	Max 60 W / 62,5 VA	
Max cable length	100 m	
Wire size	0.5 mm ² (AWG 20)	

Table 12 Output connection overview

Relay settings are available under Settings.../Interfaces.../Relay in the web interface.

3.10 USB

The reader has a USB connector that is used for service and maintenance.

Connections	USB
USB connector	Type B Jack
Speed	12 Mbps ("Full Speed")

3.11 MicroSD Memory Card Slot

The reader is equipped with a microSD memory card slot for additional storage.

Connections	MICROSD
-------------	---------

The microSD card is needed to use the built-in access controller and logging functionality. Information about the currently inserted microSD card can be found under Settings.../Interfaces.../MicroSD in the web interface. On this page it is also possible to format the microSD card.

3.12 Tamper Switch (XT Mini only)

The XT Mini reader has a tamper switch that can be connected to an external alarm loop. The circuit is broken when the lid is opened.

Connections	TMP:TMP A	
	TMP:TMP B	

3.13 DIP Switches

Two 8-position DIP switches are available for interface and software configuration.

3.13.1 Interface Configuration DIP Switch (S301)

Position(s)	Description
1-2 	RS485 2-wire mode S301:1 ON = TX+ connected to RX+ S301:2 ON = TX- connected to RX-
3 	RS485 termination S301:3 ON = 120 Ω termination between RX+ and RX-. Termination should be activated at each end of an RS485 chain.
4-5 	RS485 bias S301:4 ON = 620 Ω pull-up from RX+ to 5 V S301:5 ON = 620 Ω pull-down from RX- to 0 V Bias should be activated at one node in an RS485 chain.
6-8 	Wiegand/Magstripe pull-ups S301:6 ON = 1 kΩ pull-up from D0/CLK to 5 V S301:7 ON = 1 kΩ pull-up from D1/DATA to 5 V S301:8 ON = 1 kΩ pull-up from CL/LOAD to 5 V Pull-ups should be activated when the reader is connected to an access control system without built-in pull-ups.

Table 13 Interface Configuration DIP Switch (S301)

3.13.2 Software Configuration DIP Switch (S101)

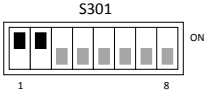
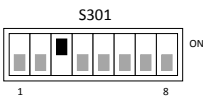
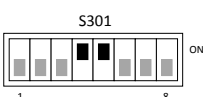
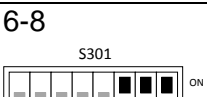

Position(s)	Description
1 	Firmware upgrade mode S101:1 is used for firmware upgrade. See section 4.4 for more information.
2 	Factory defaults S101:2 is used to restore the reader to factory default settings. See section 4.5 for more information.
3 	Fixed IP address S101:3 forces the reader to use the following IP settings: IP address: 169.254.1.1 Netmask: 255.255.0.0 A Windows PC that is directly connected to a reader is normally automatically assigned an IP address in the 169.254.x.x range. This means that it is possible to connect to a reader without changing IP settings on the PC. It may be necessary to run "ipconfig /release" if the PC has received IP settings over DHCP.
6-8 	Easy configuration S101:6-8 are used for easy configuration of Wiegand/Magstripe, OSDP, and other settings. See sections 5.1.1 and 5.2.1 for more information.

Table 14 Software Configuration DIP Switch (S101)

4 Configuration

4.1 Web Interface

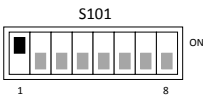
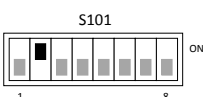
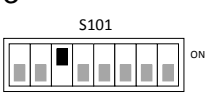
The reader has a web interface for configuration and maintenance. The web interface is designed and tested to work with Google Chrome 34, Microsoft Internet Explorer 10, and Mozilla Firefox 28.

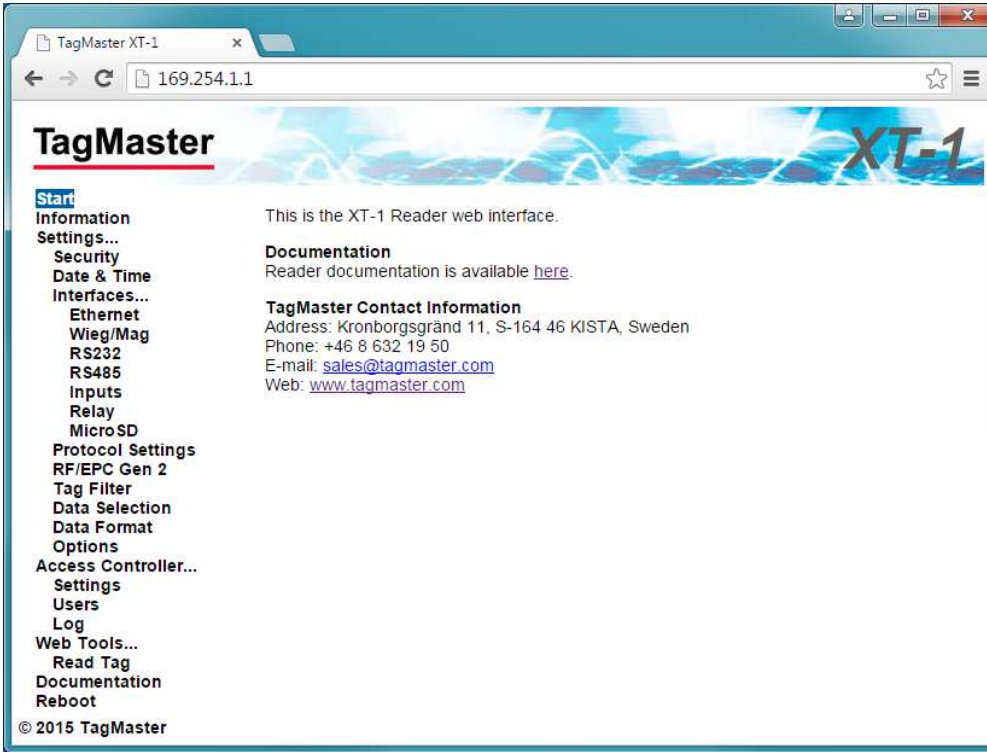

Figure 18 Web interface with expanded menu

Connect to the web interface by entering the reader's IP address in the web browser's address bar.

The reader's default IP address can be found on a label on the backside of the reader. The address is on the format 10.x.x.x with subnet mask 255.0.0.0. It is also possible to force the reader to use a fixed IP address by setting DIP switch S101:3 to ON before starting the reader. The IP address will then be 169.254.1.1 and the subnet mask 255.255.0.0. A PC that is directly connected to a reader will usually get an IP address in this subnet automatically.

If the PC does not have an IP address that is in the same subnet as the reader it is necessary to change the PC's address. In Windows 7, this is done using "Network and Sharing Center" in "Control Panel". Click on "Local Area Connection", "Properties", "TCP/IPv4", and "Properties". Select "Use the following IP address" and fill in "IP address" and "Subnet mask". If the reader has default IP settings, the values 10.0.0.10 and 255.0.0.0 can be used.

Note that the web interface may look slightly different depending on the version of the firmware in the reader. Up-to-date documentation is always available under "Documentation" in the web interface menu.

4.1.1 Start

The "Start" page provides TagMaster contact information.

4.1.2 Information

The "Information" page provides information about the system.

4.1.3 Settings...

All configuration of the reader can be done on the "Settings..." pages. For all settings, it is possible to get help by clicking on the question mark (?). Click the "Save Settings" button to activate changed settings. Click the "Factory Defaults" button to restore all settings on a page to factory defaults.

Information about important settings is available in the following sections.

4.1.4 Access Controller...

The built-in access controller is configured on the "Access Controller..." pages. See section 6 for more information.

4.1.5 Web Tools...

The "Web Tools..." pages contain tools that are useful during installation and testing.

4.1.5.1 Read Tag

The "Read Tag" page makes it easy to read tags and display tag contents.

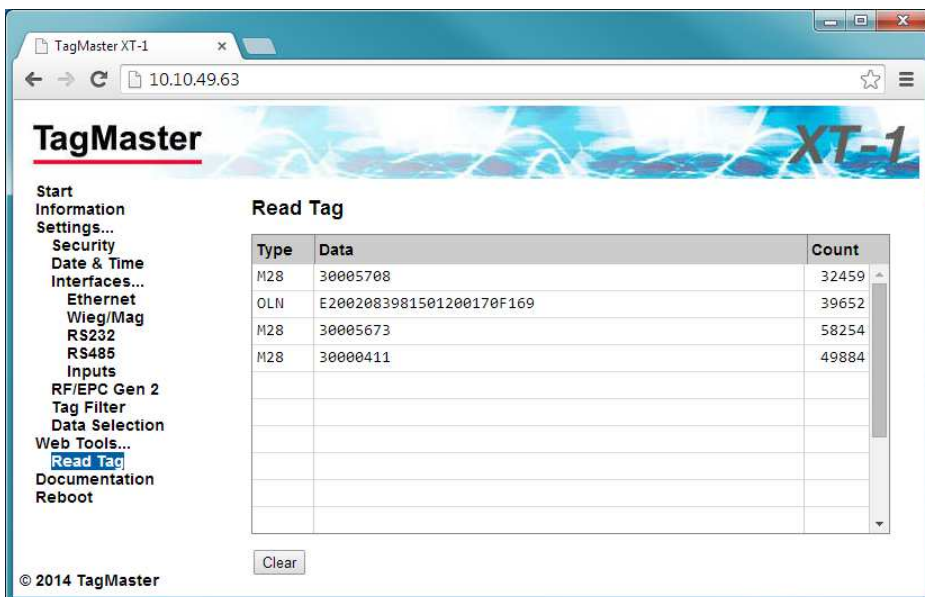

Figure 19 Read Tag

4.1.6 Documentation

The Documentation page provides up-to-date reader documentation.

4.1.7 Reboot

The Reboot page makes it easy to reboot the reader.

- Press the "Reboot" button to initiate a reboot.



- Wait for the reboot to complete.

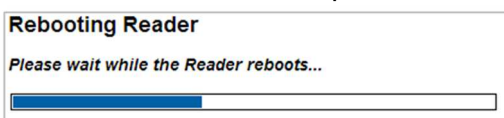

4.2 Region

To meet different radio regulations around the world, the reader can be configured to work in different regions. Each reader model comes in two versions: EU and US. Each reader version supports a number of regions as listed in the table below. Default values are shown in bold.

The region can be changed under Settings.../RF/EPC Gen 2 in the web interface.

Reader Version	Supported Regions
EU	Europe , India
US	United States , Australia, China, Malaysia, New Zealand

Table 15 Supported regions

4.3 Tag Reading

By default, the reader reads tags with maximum read range and outputs tag data in a way that is suitable for most applications. If necessary, the tag reading process is highly configurable. Most settings controlling tag reading are available under Settings.../RF/EPC Gen 2 in the web interface.

The EPC Gen 2 specification [3] mentions three operations on tag populations: select, inventory, and access. The reader automatically performs all of these when the "Carrier" setting is on. The tag reading process is shown in Figure 20 and described in the following sections.

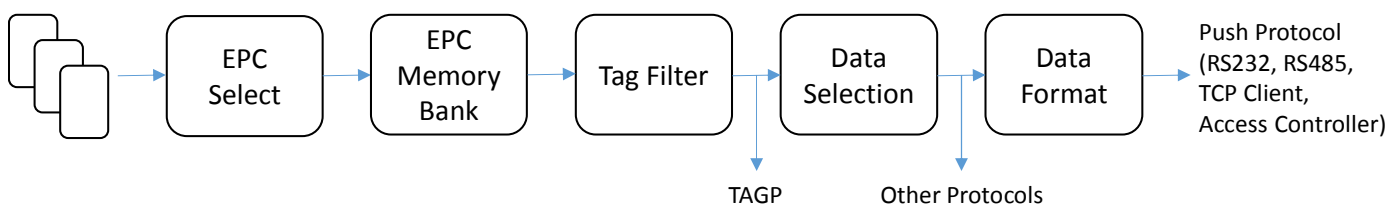

Figure 20 Reading tags

4.3.1 Carrier and Read Level

The "Carrier" setting is used to enable/disable reading. When Carrier is on (default) the reader reads tags.

The "Read level" setting controls the read range. The default value 100 corresponds to maximum read range.

4.3.2 EPC Select

The "EPC select" setting defines which tags the reader will talk to. Selection is done by specifying a binary value and a part of tag memory that must match the value. Only tags that match will respond to the reader's query. The default value "*" selects all tags.

4.3.3 EPC Memory Bank/Custom Format

The settings "EPC memory bank" and "EPC custom format" specifies which parts of the tag memory that will be read by the reader. Available options include EPC/SecureMarkID (default), SecureMarkID, EPC, TID and "Custom Format".

If "EPC memory bank" is set to "Custom Format" the "EPC custom format" setting specifies which parts of the tag memory that will be read.

4.3.4 Tag Filter

The tag filter (under Settings.../Tag Filter in the web interface) specifies how often tags are reported. Tags can be reported every time they are read, periodically or once. It is also possible to get a tag event when a tag is no longer read by the reader. It is possible to activate read beep and read blink to get an indication every time a tag is reported.

The TAGP protocol reports tag events as they come out of the tag filter.

4.3.5 Data Selection

The "Data selection" settings (under Settings.../Data Selection in the web interface) specifies how the read data shall be interpreted (binary, hexadecimal or decimal) and also makes it possible to select a part of the data (number of digits with a left or right aligned offset).

Reader protocols with binary output reports data as it comes out of this stage.

4.3.6 Data Format

The "Data Format" settings (under Settings.../Data Format in the web interface) specifies the output format for data that is pushed to RS232, RS485, TCP Client, and the built-in access controller.

4.4 Firmware Upgrade

Download the latest firmware version from <ftp://partner:245ghz@ftp.tagmaster.com/Vigilant/Firmware>.

Go to the "Reboot/Upgrade" page on the web interface, check "Start boot loader" and press the "Reboot" button to start the boot loader. In the boot loader, press "Choose File" and choose the downloaded firmware file. Press "Upgrade" to start the upgrade and then press "Reboot" when the upgrade has finished.

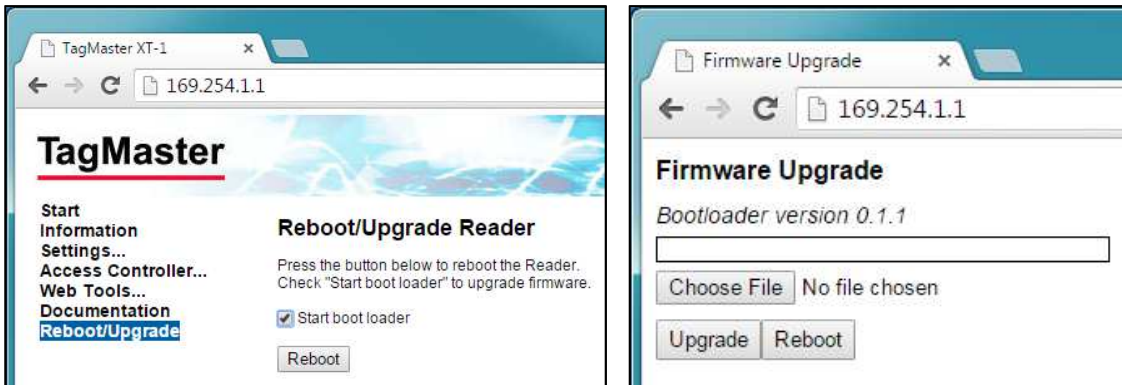

Figure 21 Starting the boot loader to upgrade firmware

Note: The boot loader was added in firmware version 1.2.0. To upgrade from earlier versions, follow the instructions in the README document that is available in the same FTP directory as the firmware.

4.5 Factory Defaults

Use the following procedure to restore the reader to factory default settings:

1. Set DIP switch S101:2 to ON

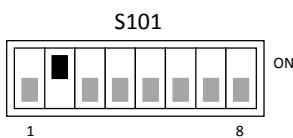

2. Power cycle the reader
3. Set DIP switch S101:2 back to OFF

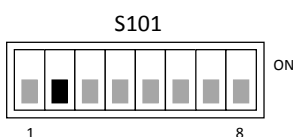

5 Connecting to an External System

The following sections describe how to connect the reader to another system. Note that the reader requires more power than a typical proximity reader and should have its own power supply.

5.1 Wiegand/Magstripe

The reader can be connected to a typical access control system using Wiegand/Magstripe. The access control system can control the reader's LED indicator using inputs IN1 and IN2. Input IN3 can be connected to a presence detector such as an inductive loop. An overview is shown in Figure 22.

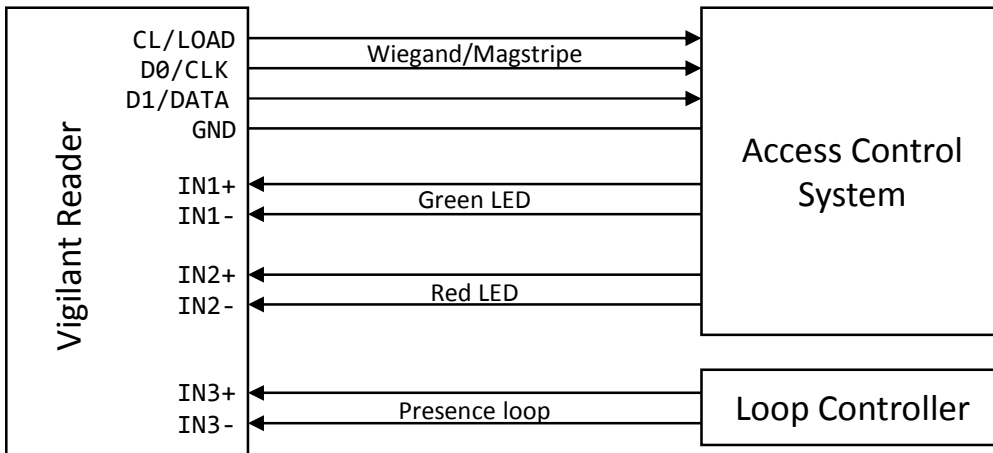

Figure 22 Reader connected to access control system using Wiegand/Magstripe

For common access control systems, the reader can be configured using DIP switches as described in section 5.1.1, "Easy Configuration", below. For other systems, all Wiegand/Magstripe settings are available under Settings.../Interfaces.../Wieg/Mag in the web interface.

5.1.1 Easy Configuration

The reader can be configured to work with common access control systems using DIP switches S101:6-8. When any of these switches are in the ON position, the reader is configured to report tags once, accept SecureMarkID tags only, and use the specified Wiegand/Magstripe format.

The following sections describe how to connect the reader to different access control systems and how to set the reader's DIP switches. The following format is used to describe cable connections:

[READER SIGNAL] → [ACCESS CONTROL SYSTEM SIGNAL]

5.1.1.1 ASSA ARX/RX WEB (with 500RW22)

Configure the ARX/RX WEB system to use card type Wiegand.

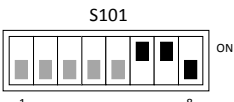
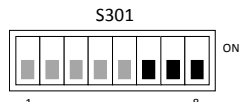
GND → 0V	IN1+ → 12V
CL/LOAD → N/C	IN1- → LED_GREEN
D0/CLK → D0	IN2+ → 12V
D1/DATA → D1	IN2- → LED_RED
S101 - Wiegand format: W34N 	S301 - Vigilant pull-ups disabled 

Tested version: RX WEB PR300233 build-8418 version-17.2.0.5

5.1.1.2 **AXIS A1001**

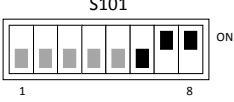
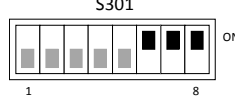

Configure A1001 to use reader protocol Wiegand with "Dual LED" and set the card format to H10302.

GND → [READER I/O] -	IN1+ → [READER I/O] 12V
CL/LOAD → N/C	IN1- → [READER I/O] I05
D0/CLK → [READER DATA] D0	IN2+ → [READER I/O] 12V
D1/DATA → [READER DATA] D1	IN2- → [READER I/O] I04
S101 - Wiegand format: W37N/H10302 	S301 - Vigilant pull-ups enabled 

Tested version: Firmware version 1.30.0

5.1.1.3 **Bewator Entro**



Configure the Bewator Entro system to use H10302 format.

GND → 0V	IN1+ → N/C
CL/LOAD → N/C	IN1- → N/C
D0/CLK → D0/CLK	IN2+ → N/C
D1/DATA → D1/DATA	IN2- → N/C
S101  Bewator Entro ≥ 6.5: Wiegand format: W37N/H10302  Older versions: Wiegand format: W37R/H10302	S301 - Vigilant pull-ups disabled 

Tested version: Bewator Entro 6.55.011

5.1.1.4 **Bewator Omnis (with E2V)**

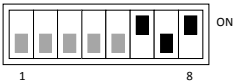
The Vigilant reader behaves as a RB500 reader in Clock&Data mode.

GND → [Conn. G] -	IN1+ → [Conn. G] +12V
CL/LOAD → [Conn. E] A	IN1- → [Conn. G] G
D0/CLK → [Conn. E] B	IN2+ → [Conn. G] +12V
D1/DATA → [Conn. E] C	IN2- → [Conn. E] R
S101 - Magstripe format: M8N/H10320 	S301 - Vigilant pull-ups enabled 

Tested version: Bewator Omnis 6.0.107

5.1.1.5 Paxton Net2 Plus

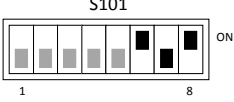
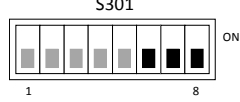

Configure the Paxton system to use reader type "Clock & Data".

GND → 0V	IN1+ → 12V
CL/LOAD → N/C	IN1- → Green LED
D0/CLK → Clock/D1	IN2+ → 12V
D1/DATA → Data/D0	IN2- → Red LED
S101 - Magstripe format: M8N/H10320 	S301 - Vigilant pull-ups disabled 

Tested version: Net2 Lite version 4.28.8417

5.1.1.6 RCO R-CARD M5 (with DB-50W)

The RCO system automatically detects the Wiegand format.

GND → DC-	IN1+ → N/C
CL/LOAD → N/C	IN1- → N/C
D0/CLK → DATA0	IN2+ → N/C
D1/DATA → DATA1	IN2- → N/C
S101  Strap at P14*: Wiegand format: W34N  No strap at P14: Wiegand format: W26S/H10302	S301 - Vigilant pull-ups enabled 

* To get all digits from the SecureMarkID tag, it is necessary to solder a strap at P14 on the RCO DB-50W board. Without this strap it is only possible to get the last four digits from the tag.

5.1.1.7 Vanderbilt Aliro

On the circuit board in the access point, set the EOL jumper for the reader to OFF. In the Aliro software, set reader type to "Wiegand" and card format to "H10302_37". Configure Output_1 to "C&D/Wiegand green" and Output_2 to "C&D/Wiegand red".

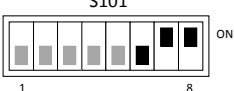
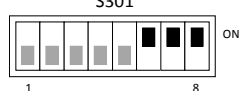
GND → [READER n] -	IN1+ → [READER n] +
CL/LOAD → N/C	IN1- → [OUT 1/2] 1
D0/CLK → [READER n] A	IN2+ → [READER n] +
D1/DATA → [READER n] B	IN2- → [OUT 1/2] 2
S101 - Wiegand format: W37N/H10302 	S301 - Vigilant pull-ups enabled 

Tested version: Software version 1.0.0.5371, Access point firmware version 1.0.0.2022

5.2 OSDP (RS485)

The reader supports the Open Supervised Device Protocol (OSDP) [4] for connection to access control systems. OSDP communicates over 2-wire RS485 and can therefore be used with long cables and does not require extra cables for LED and buzzer control. The DIP switch S301:1-2 must be set to ON to enable 2-wire mode on the reader. In most cases S301:3-5 should also be set to ON to enable biasing and termination. Input IN3 can be connected to a presence detector such as an inductive loop. Figure 23 shows a typical connection diagram and the most common settings for DIP switches S101 and S301.

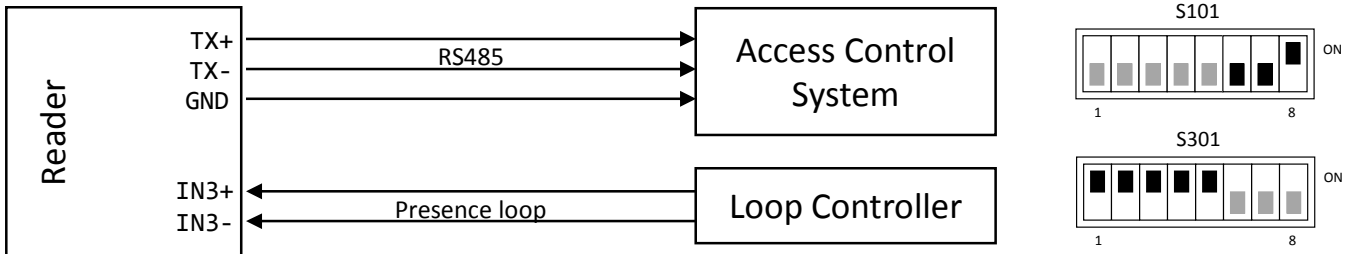

Figure 23 Reader connected to access control system using OSDP

All OSDP settings are available under Settings.../Protocol Settings.../OSDP. For common access control systems, OSDP can also be enabled using DIP switch S101 as described below.

5.2.1 Easy Configuration

5.2.1.1 Default OSDP Mode

DIP switches S101 and S301 as shown in Figure 23.

5.2.1.1.1 AXIS A1001

In the A1001 software, set the reader protocol to OSDP, RS485 half duplex. Define a new card format with name SecureMarkID and bit length 32. Set the field map like this: Name: CardNr, Range: 1-32, Encoding: BinLE2Int*.

RS485:TX+ → [READER DATA n] B+	RS485:GND → [READER I/O n] -
RS485:TX- → [READER DATA n] A-	

Tested version: Firmware version 1.30.0

5.2.1.1.2 Bravida Integra

In the Bravida Integra Software: Set the communication protocol for card reader to OSDP. In card reader, define proper card system. Set card data byte order to "MSB". Set device bus address to 1.

RS485:TX+ → PL400-3 +	RS485:GND → -
RS485:TX- → PL400-4 -	

Tested version: Integra SW version 7.0, C-NodeG2 FW version 21.70, S-NodeG2 FW version 20.20

5.2.1.2 Vanderbilt Aliro

In the Aliro software, set reader type to "Siemens OSDP".

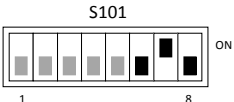
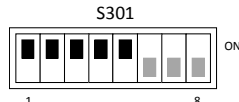
RS485:TX+ → [READER n] A	RS485:GND → [READER n] -
RS485:TX- → [READER n] B	
S101 - Aliro emulation mode 	S301 - 2-wire RS485 with bias and termination 

Tested version: Software version 1.0.0.5371, Access point firmware version 1.0.0.2022

5.3 Push (RS232, RS485, TCP/IP)

When a tag has been read, the reader can automatically push tag data to RS232, RS485 and a specified TCP server. The Push protocol is enabled by default on RS232 and RS485. To push data to a TCP server it is necessary to specify the IP address and TCP port of the server and enable the Push protocol under Settings.../Interfaces.../Ethernet in the web interface.

The format of the pushed data can be configured under Settings.../Data Format. The default format is decimal for SecureMarkID tags and hexadecimal for other tags.

5.4 TAGP (TCP/IP)

TagMaster Readers can be controlled and monitored using a protocol called TAGP. The TAGP protocol is human readable and can be used over TCP/IP, RS232 and RS485. A terminal emulation program such as PuTTY is all that is required to interact with TAGP.

The "TAGP Protocol Specification" [2] can be downloaded from www.tagmaster.com. Use login name "partner" and password "245ghz".

PuTTY TagMaster Edition can be downloaded from <ftp://partner:245ghz@ftp.tagmaster.com>.

All TAGP messages start with a 4-character message identifier and ends with a new line character. To initiate communication with the TAGP server in the reader, a client has to send a HELO message specifying the required TAGP version. The TAGP server replies with a RPLY message:

```
HELOTAGP/2
RPLYHELO00
```

The client can then send commands to the reader. The most important commands are SET, SETS, GET, and GETS. SET and GET sets and gets the current value of a variable. SETS and GETS sets and gets the stored value of a variable. The stored value is used to initialize the variable at startup. The following example shows how to set the LED to green:

```
SET LED=GREEN
RPLYSET 00
```

The reader sends events to the client when something happens. The following example shows a TAG event that is sent when a tag has been read:

```
EVNTTAG 20140416151015810%00%07'%141%00%00%00%00%00%00%00
```

5.5 Other Protocols

The reader supports a number of OEM protocols, including SKIDATA BLL4 and Kaba BPA/Bedanet. These protocols are documented in separate protocol manuals that can be downloaded from www.tagmaster.com.

6 Built-in Access Controller

The reader has a built-in access controller that can control a barrier or gate using the reader's relay output. All accesses can be logged. A presence indicator such as an inductive loop can be connected to input 3.

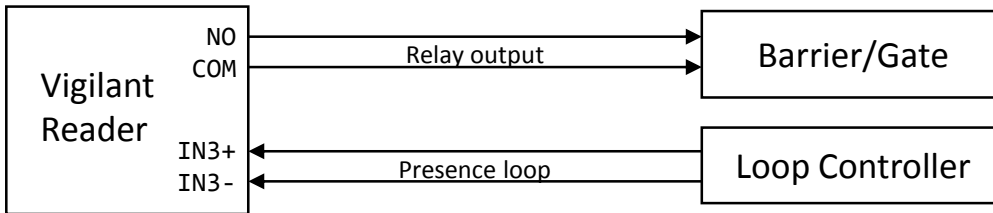

Figure 24 Built-in access controller connection diagram

To use the access controller or log, a microSD card must be inserted into the microSD memory card slot. Make sure to power off the reader before inserting or removing the microSD card!

The built-in access controller is configured using the web interface as shown in Figure 25.

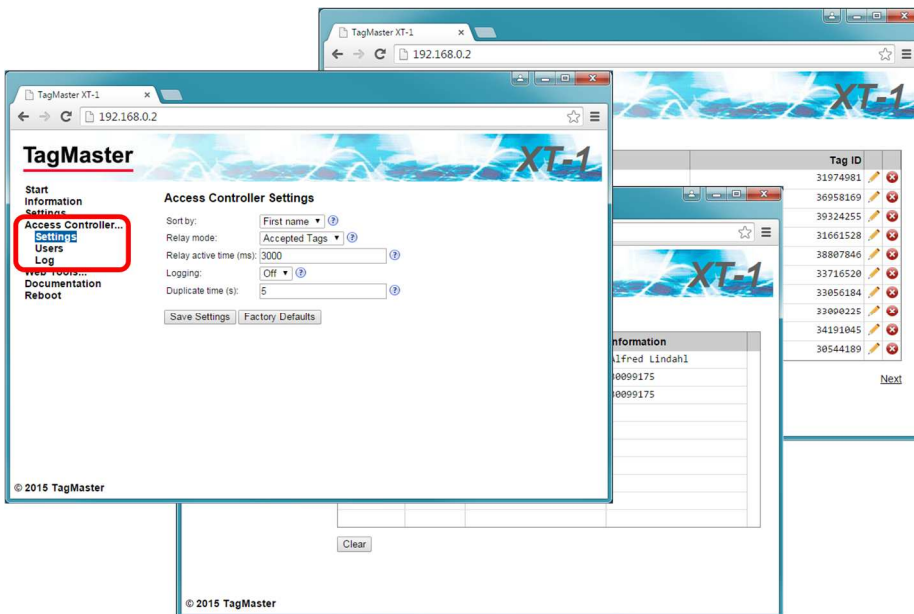

Figure 25 Built-in access controller web interface (Settings, Users, Log)

Max number of users	1000
Max number of log entries	1000

7 Troubleshooting

To facilitate troubleshooting, consider the following:

- Make sure that the reader has correct supply voltage and sufficient current. Check the small green LED on the controller board inside the reader. When the LED is flashing (once per second) the reader is powered and the firmware is running. If the LED is on, but not flashing, the reader is powered but the firmware is not running. If the LED is off, the reader is not powered.
- If using Ethernet communication, make sure that the network connection is ok. There are small LEDs on or close to the RJ45 socket, only visible when the lid of the reader is open. A yellow light indicates 'Link' and a flashing yellow light indicates 'Activity'.
- If the IP address has been forgotten or firmware settings have been corrupted the reader can be restored to factory default settings as described in section 4.5.
- Make sure that working and correctly formatted EPC Gen 2 tags are being used.

8 Definitions and Abbreviations

AES	Advanced encryption standard
ASCII	American standard code for information interchange
AWG	American wire gauge
CR	Carriage return
DES	Data encryption standard
DIP	Dual in-line package
EPC	Electronic product code
FCC	Federal communications commission
LED	Light emitting diode
LF	Line feed
OEM	Original equipment manufacturer
RFID	Radio-frequency identification
PC	Personal computer
SecureMarkID®	A TagMaster implementation for improved Security using EPC tags
TAGP	A TagMaster protocol for RFID reader communication
TCP/IP	An Internet protocol suite
UMK	Universal mounting kit
USB	Universal serial bus

9 References

- [1] [06-147 UMK 193600 DATA SHEET](#)
- [2] [05-172 TAGP PROTOCOL SPECIFICATION](#)
- [3] [EPC GEN 2 SPECIFICATION V.2.0.1, HTTP://WWW.GS1.ORG](#)
- [4] [SIA OPEN SUPERVISED DEVICE PROTOCOL, HTTP://WWW.SIAONLINE.ORG](#)

Manuals and documentation can be downloaded from www.tagmaster.com.

10 Technical Specification

	XT-1	XT Mini
Operating frequencies	XT-1 eu: 865.6-867.6 MHz XT-1 us: 902-928 MHz	XT Mini eu: 865.6-867.6 MHz XT Mini us: 902-928 MHz
Read range	Up to 8 m (26 ft)	Up to 3 m (10 ft)
Dimensions	300x300x60 mm (11.8x11.8x2.4 in)	261x152x55 mm (10.3x6.0x2.2 in)
Weight	2.3 kg (5.1 lbs)	0.8 kg (1.8 lbs)
Housing	Aluminium housing UL94 certified XENOY™ cover	UL94 certified plastic XENOY™
Part No.	XT-1 eu: 152500 XT-1 us: 152600	XT Mini eu: 152300 XT Mini us: 152400
Output power	XT-1 eu: 2W (e.r.p.) XT-1 us: 4W (e.i.r.p.)	< 500 mW (e.r.p)
FCC ID	M39XTXX	M39XTMX
Power consumption	10W (max 12W)	4W (max 5W)
Ingress protection	IP 66	
Operating temperature	-40°C to +60°C (-40°F to +140° F) EN 60068-2-1 Ad, EN 60068-2-2 Bd, EN 60068-2-14 Nb	
Storage temperature	-40°C to +85°C (-40°F to +185°F)	
Power supply	12-24 VDC supply	
Inputs	3 isolated inputs	
Outputs	3 isolated outputs shared with Wiegand/Magstripe	
Relay	1 relay output 60VDC, 2A	
Interfaces	RS232, RS485, Wiegand/Magstripe, Ethernet (2 ports on XT-1), USB service Interface, Tamper switches (XT Mini only)	
Certificates	CE Certificate according to R&TTE-directive 1999/5/EC and FCC RoHS Directive 2002/95/EC and 2011/65/EU WEEE 2002/96/EC	
Standards	EPC Gen 2 (ISO 18000-63)	
EMC	EN 301489-1, EN 301489-3	
Radio	EN 302 208-1, EN 302 208-2 FCC: CFR 47, Part 15 subpart C	
Safety & health	EN 60950-1, EN 60950-22 & 1999/519/EC	
Mechanical	EN 60068-2-27 Ea, EN 60068-2-64 Fh	
Manuals and documentation	XT-1/XT Mini Manual, 13-111 TAGP Manual, 05-172	
Accessories	Universal Mounting Kit: 193600 ISOcard ID-tag: 225000 WindShield ID-tag: 221000	
Communication protocols	TAGP, OSDP, and various OEM protocols	

Technical Support

Phone: +46 8 632 19 50

E-mail: support@tagmaster.com

Office Address

TagMaster AB

Kronborgsgränd 11

164 46 KISTA

SWEDEN

Phone: +46 8 632 19 50

E-Mail: sales@tagmaster.com

Web: www.tagmaster.com

TagMaster
